

Toroidal transformer type 17610

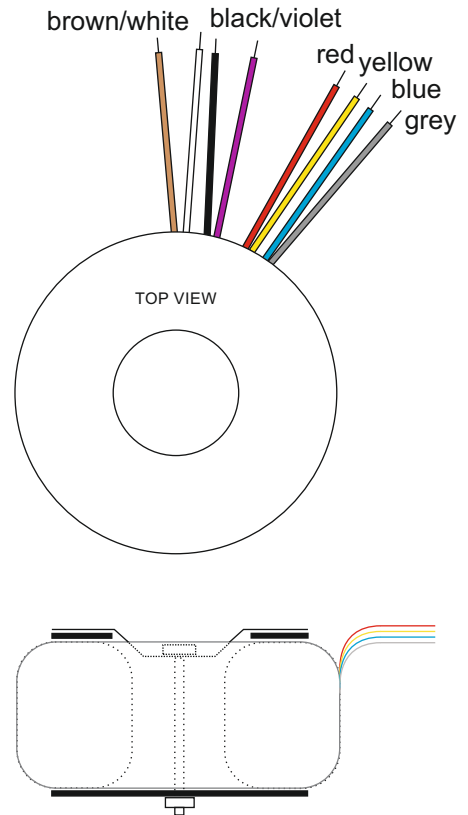

Diameter approx. 71mm  
 Height approx. 32mm  
 Weight approx. 0.5kg  
 Height and weight are measured without mounting materials  
 All leads approx. 200mm long

Supplied mounting materials:  
 1 metal washer  
 2 neoprene washers  
 1 bolt with nut

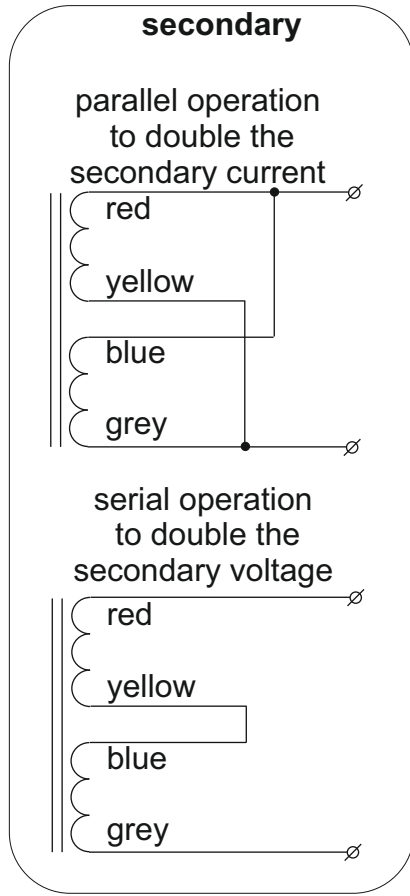
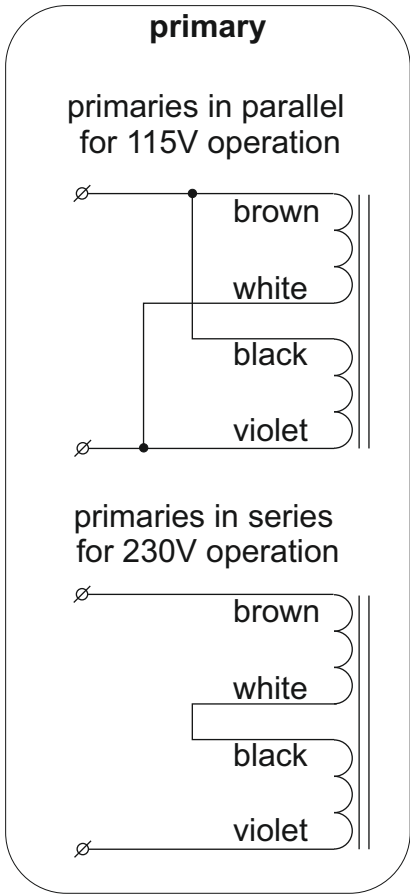
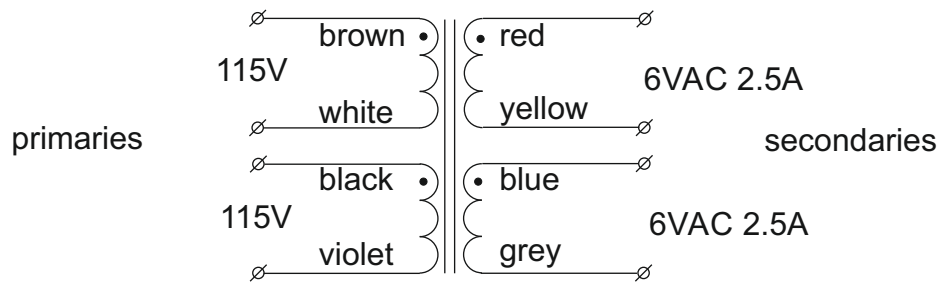

according to EN61558. With CE and UL/CSA approvals  
 UL filenumber E311200.  
 RoHS-compliant

Type number	primary	secondaries voltage	current
17610	2x115V	2x 6V	2.5A

All voltages are under full ohmic load  
 Regulation : 13.7%



P/N AMP-0030006  
 TYPE 17610  
 BATCH 00000

CE     
 50/60Hz  
 MADE IN CHINA

PRI. 2x 115VAC BROWN-WHITE / BLACK-VIOLET  
 SEC. 2x 6VAC 2.5A RED-YELLOW / BLUE-GREY  
 Amplimo BV, Industrieweg 14, 7161BX, NEEDE, NL WWW.AMPLIMO.NL

	Industrieweg 14 7161BX NEEDE The Netherlands  P O - B o x 2 7 NL-7160AA NEEDE The Netherlands Tel.+31 (0)545 283456 Fax+31 (0)545 283457 info@amplimo.nl http://www.amplimo.nl	HB	Aug 2017	<p><b>17610</b>                  P/N: AMP-0030006</p>
	© Copyright Amplimo BV		toroidal transformer 30VA	